

# MARLEY STRATUS DESIGN SERIES®

Design and  
Installation Guide



BLACK



GREY FRIARS®



IRONSAND®



GULL GREY



FLAXBLACK®



TITANIUM



COPPER

# Marley Stratus Design Series®

New Zealanders have trusted Marley spouting and downpipe systems to protect their homes from the elements for over 40 years. Marley is proud to introduce our new generation of designer uPVC spouting and downpipe systems. Inspired by nature the Marley Stratus Design Series® is created with style and durability in mind.

When renovating, replacing existing spouting or building a new home, the Marley Stratus Design Series® offers a premium sophisticated look while protecting your home from the elements. For an innovative New Zealand manufactured solution insist on the Marley Stratus Design Series® for style without compromise.

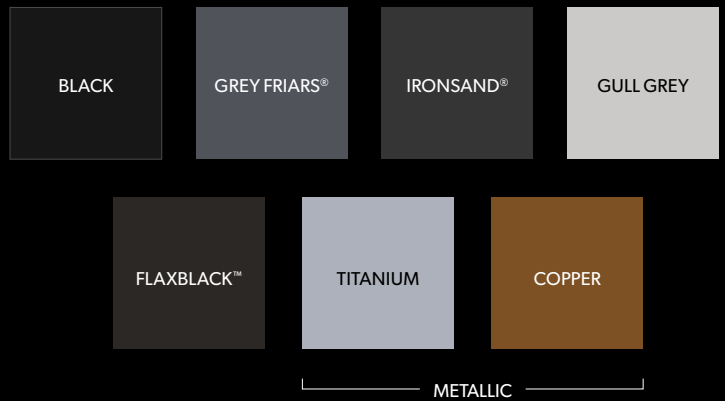

# CONTENTS

<b>SECTION 1:</b>	<b>1.0 PRODUCT LIST</b>	<b>4</b>
	1.1 Typhoon® spouting system	4
	1.2 Stormcloud® spouting system	5
	1.3 RP80® 80mm round downpipe system	6
<b>SECTION 2:</b>	<b>2.0 SYSTEM OVERVIEW</b>	<b>8</b>
	2.1 Application	8
	2.2 Non standard application use	8
	2.3 Guarantee	8
	2.4 Durability	8
	2.5 Environmental	8
	2.6 Quality accreditation	8
	2.7 Water collection – Drinking water	8
<b>SECTION 3:</b>	<b>3.0 DESIGN DETAILS</b>	<b>8</b>
	3.1 Dimensions	8
	3.2 Flow characteristics	9
	3.3 Wet system – Head pressure	9
	3.4 Fabrication	9
	3.5 Snow loading / Wind effect	10
	3.6 Colour durability	10
	3.7 Overflow allowance	10
<b>SECTION 4:</b>	<b>4.0 INSTALLATION INSTRUCTIONS</b>	<b>11</b>
	4.1 Planning & Preparation	11
	4.1.1 Roof overhang	11
	4.1.2 Solvent welding procedure	11
	4.1.3 Thermal movement	12
	4.1.4 Water flow direction – High point to Low point	14
	4.1.5 Recommended fall	14
	4.2 Stormcloud® / Typhoon® Spouting Installation	14
	4.2.1 Bracket positioning	14
	4.2.2 Bracket fixing	15
	4.2.3 Installing the expansion outlet	16
	4.2.4 Inserting the spouting into the brackets	16
	4.2.5 Inserting the spouting into the expansion outlet	17
	4.2.6 Inserting the stop end to an expansion outlet	17
	4.2.7 Expansion joiner setup	17
	4.3 Spouting Installation Scenarios	18
	4.3.1 Spouting run to an expansion outlet	18
	4.3.2 Spouting run with an expansion joiner	18
	4.3.3 Spouting run to dropper outlet	18
	4.3.4 Spouting run to an expansion outlet	19
	4.3.5 Spouting run with an expansion joiner	20
	4.3.6 Spouting run with a dropper outlet	21
	4.4 RP80® 80mm Round Downpipe Installation	22
	4.4.1 Soffit offset assembly	22
	4.4.2 Downpipe joiner	22
	4.4.3 Direct connection of RP80® to outlet	22
	4.4.4 Installing downpipe clips	23
	4.4.5 Installing the downpipe junction	24
	4.4.6 Downpipe to stormwater connection	24
	4.4.7 Downpipe Spreader Kit	24
	4.4.8 Curve® Leaf Diverter	25
	4.4.9 Twist® Rainwater Diverter	25
<b>SECTION 5:</b>	<b>5.0 MAINTENANCE AND HANDLING</b>	<b>25</b>
	5.1 Maintenance	25
	5.2 Touch up paint	26
	5.3 Storage	26
	5.4 Handling	26
<b>SECTION 6:</b>	<b>6.0 GUARANTEE</b>	<b>27</b>

# 1.0 PRODUCT LIST

## 1.1 TYPHOON® SPOUTING SYSTEM

The Marley Typhoon® half-round spouting system is designed specifically for New Zealand homes and conditions with excellent rainfall capacity and flow. Its contemporary design offers a choice of either internal brackets (for a clean finish) or external brackets (for a unique look and ease of cleaning).



When selecting a colour add the corresponding colour extension to the product code.

E.g. MT1.4.**COP** = Typhoon 4m length in Copper

### COLOUR CODE EXTENSION

BLACK **.BLK**

GREY FRIARS® **.GYF**















IRONSAND® **.IRO**

GULL GREY **.GGY**

FLAXBLACK® **.FXB**

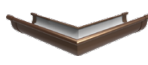
TITANIUM **.TTN**

COPPER **.COP** (Pictured)

COMPONENT	PRODUCT	PRODUCT CODE
Typhoon® Spouting 4m Length		MT1.4.__
Internal Bracket		MT2I.__
External Bracket		MT2E.__
Expansion Outlet 80mm		MT8.80.__
Dropper Outlet 80mm		MT11.80.__
Joiner		MT5.__
Expansion Joiner		MT17.__
External Angle 90°		MT6.__
Internal Angle 90°		MT7.__
Left Hand Stopend		MT3.__
Right Hand Stopend		MT4.__
Special Spouting Angle - Flat		MTSPEC.F.__
Special Spouting Angle - Rake		MTSPEC.R.__
Solvent Welding Cement - 180g Tube		MCS.__
Bracket screws for metal fascia		SCREW.METAL

## 1.2 MARLEY STORMCLOUD® SPOUTING SYSTEM

New Zealand's favourite quarter round spouting profile joins the Marley Stratus Design Series® presenting sharp, clean lines that frame your home with a modern gloss colour finish. Available with internal brackets, Marley Stormcloud® is a versatile profile that has truly stood the test of time.



When selecting a colour add the corresponding colour extension to the product code.

E.g. MS1.4.**GYF** = Stormcloud 4m length in Grey Friars®

### COLOUR CODE EXTENSION













BLACK **.BLK**

GREY FRIARS® **.GYF** (Pictured)

IRONSAND® **.IRO**

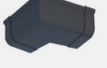
GULL GREY **.GGY**

FLAXBLACK® **.FXB**

COMPONENT	PRODUCT	PRODUCT CODE
Stormcloud® Spouting 4m Length		MS1.4.__
Stormcloud® Bracket		MS2.__
Expansion Outlet 80mm		MS8.80.__
Expansion Outlet 65mm		MS8.65.__
Joiner		MS5.__
Expansion Joiner		MS17.__
External Angle 90°		MS6.__
Internal Angle 90°		MS7.__
Left Hand Stopend		MS3.__
Right Hand Stopend		MS4.__
Special Spouting Angle - Flat		MSSPEC.F.__
Special Spouting Angle - Rake		MSSPEC.R.__
Solvent Welding Cement - 180g Tube		MCS.__
Bracket screws for metal fascia		SCREW.METAL

FlaxBlack® is a colour match for NZ Steel's COLORSTEEL® FlaxPod®. Marley NZ Ltd is not affiliated with NZ Steel Ltd. Note gloss levels may vary between building materials. Actual colours may vary slightly from those shown. For a more accurate colour comparison, please request a product sample.

### 1.3 RP80® 80MM ROUND DOWNPIPE SYSTEM

The most popular downpipe system in New Zealand for the last 30 years. The Marley RP80® 80mm round downpipe system offers strong performance, good looks and easy installation on either Marley uPVC or metal spouting systems.



When selecting a colour add the corresponding colour extension to the product code.

E.g. RP80.**IRO** = RP80 3m length in Ironsand®

#### COLOUR CODE EXTENSION

BLACK **.BLK**

GREY FRIARS® **.GYF**

IRONSAND® **.IRO** (Pictured)

GULL GREY **.GGY**

FLAXBLACK® **.FXB**

TITANIUM **.TTN**

COPPER **.COP**



COMPONENT	PRODUCT	PRODUCT CODE
Round Downpipe 80mm 3m Length NB: Nonsocketed – use jointing socket RS80.TTN		RP80.__
95° F+F Bend 80mm		RB2.80.__
95° M+F Bend 80mm		RB4.80.__
43° F+F Bend 80mm		RB3.80.__
43° M+F Bend 80mm		RB5.80.__
Jointing Socket 80mm		RS80.__
95° Junction 80mm		RJ80.__
Pipe Clip-Saddle 80mm		RC80.__
Pipe Clip Adjustable 80mm Ideal for weatherboards		RC80.2.__
Pipe Clip Adjustable Spacer 80mm For stepped cladding systems		RC80.2S.__
Adaptor 80 to 90mm		RA80.90.__
Adaptor 80 to 100mm		RA80.100.__
Downpipe Spreader Kit 80mm		SKIT80.__
End Cap 80mm		CS80.__
Dropper Outlet Also for connecting RP80® to metal spouting		MC11.80.__
Curve® Leaf Diverter Protect water tanks		CURVE.__
Twist® Water Diverter For extra water supply		TWIST.__
Solvent Welding Cement - 180g Tube		MCS.__

# QUICK TIP GUIDE

## FOR INSTALLING MARLEY UPVC SPOUTING

### 1. ENSURE CORRECT FALL

Water flow is to be directed from a high point to the low point where the downpipe is. Marley spouting runs must be installed with a drop from the high point to the low point of 5mm per 10m (or 0.5mm per 1m).

*See section 4.1.4 Water Flow Direction – High Point to Low Point.*

### 2. ENSURE CORRECT BRACKET SPACING

Brackets must be installed no more than 500mm apart using at least 3 screws per bracket. Spacing should be reduced to 300mm in high wind zones. Note specific spacing requirements around corners and outlets.

*See section 4.2.1 Bracket Positioning*

### 3. ALLOW FOR EXPANSION AND CONTRACTION

Like many building materials uPVC spouting expands and contracts with temperature changes. To manage thermal movement Expansion Outlets should be used as the default downpipe dropper. 12m of coloured spouting can be installed either side of an expansion outlet. For runs exceeding 12m Expansion Joiners should also be used.

*See section 4.1.3 Managing Thermal Movement*

### 4. FIX SPOUTING TO CONTROL CREEP

Use a stainless-steel screw to fix the spouting to the fascia to ensure any movement is directed to the expansion outlet/s. Generally, this will be next to a stop end at the opposite end of the run to the expansion outlet, or in the middle of a run where there is an outlet at each end of the run.

*See section 4.1.3 Managing Thermal Movement*

### 5. USE ONLY MARLEY MCS SOLVENT CEMENT

Marley MCS is a combination glue/filler designed to help ensure no join gaps. Using any other solvent will invalidate our 15-year rainwater guarantee. MCS is available in all Marley spouting colours.

*See section 4.1.2 Solvent Welding Procedure*

## 2.0 SYSTEM OVERVIEW

### 2.1 APPLICATION

Marley New Zealand Limited uPVC spouting and downpipe systems are designed for the collection and discharge of rainwater from roof areas. Marley uPVC spouting and downpipe systems are suitable ONLY as external spouting and downpipes and are NOT suitable for use as a concealed system.

- Marley spouting systems should not be installed as an internal spouting system.
- Marley downpipe systems should not be installed in wall or ceiling cavities.

### 2.2 NON STANDARD APPLICATION USE

If Marley uPVC spouting and downpipe systems are to be used in any applications not covered by the current Marley literature, written confirmation of suitability should be obtained from Marley.

### 2.3 GUARANTEE

Marley New Zealand Limited (Marley) guarantees the purchaser of Marley spouting or downpipe products (Products) against defects in material and manufacture (Guarantee) for a period of 15 years from the original date of purchase (Guaranteed Period). See page 27 of this guide for further details.

### 2.4 DURABILITY

Marley uPVC spouting and downpipe systems are suitable as external spouting and downpipes exceeding the minimum five years durability requirements of the New Zealand Building Code clause B2/AS1 table 1. With correct installation and maintenance, Marley uPVC spouting and downpipe systems will perform well in excess of the 15 year guarantee period. A regular cleaning programme is essential to maintain the performance and appearance of the system.

### 2.5 ENVIRONMENTAL

Marley uPVC spouting and downpipe systems are 100% recyclable and Marley operates recycling facilities on and off site. All Marley manufactured uPVC spouting and downpipe systems are made using Best Environmental Practice (BEP) and as such attract positive credits under the NZ Green Building Council's Green Star rating system for commercial buildings. Environmental Product Declarations (EPDs) for Marley PVC spouting and downpipe products are available on Marley's website.

### 2.6 QUALITY ACCREDITATION

Marley operates Quality and Environmental Management Systems that are registered by Bureau Veritas as complying with ISO 9001 : 2015 Certification No. NZ002067-1 and ISO 14001 : 2015 Certification No. NZ002068-1.

### 2.7 WATER COLLECTION – DRINKING WATER

All Marley uPVC spouting and downpipe systems are suitable for the collection of rainwater for drinking purposes. Marley uPVC spouting and downpipe systems have been tested and comply with, AS/NZS 4020. Testing of products for use in contact with drinking water. This includes the Marley MCS<sup>®</sup> Solvent Cement specifically designed for use with Marley's spouting and downpipe systems.

If larger diameter pipe systems are required for water collection and/or connection to water tanks, the Marley Optim<sup>®</sup> DWV system also complies with AS/NZS 4020 as does our Marley Stormline<sup>®</sup> Stormwater system\*.

Please contact Marley should you require any clarification on suitability for use with drinking water.

As spouting and downpipes form only part of a complete rainwater collection system, care should be taken to ensure water is not contaminated by other sources.

## 3.0 DESIGN DETAILS

### 3.1 DIMENSIONS (all dimensions are nominal)

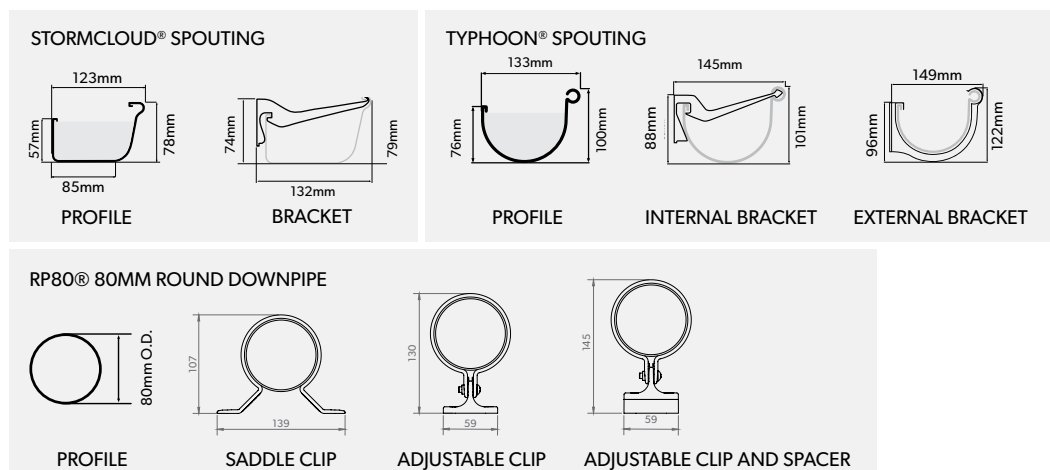

\*Only Marley Stormline<sup>®</sup> Stormwater pipe manufactured at our Auckland site has been tested and certified to comply with AS/NZS 4020.



### 3.2 FLOW CHARACTERISTICS

Marley uPVC spouting and downpipe systems have been designed to optimise the discharge of water. Selection of profile and downpipe size is dependent upon the roof catchment area and the rainfall intensity for the region where the product is being installed. Applying fall to the spouting improves the flow and the location of the outlets can also influence the flow. The New Zealand Building Code Approved Document E1 references downpipes and spouting in the Acceptable Solution E1/AS1 Clauses 4.0 and 5.0. More detailed spouting design can be found in AS/NZS3500.3

#### Stormcloud® Spouting System

Flow Capacity: 70 litres/minute  
Cross-sectional area: 5100mm<sup>2</sup>

#### Maximum Roof Area per downpipe (m<sup>2</sup>)

Rainfall Intensity* (mm/hr)	40	50	60	70	80	90	100	110	120	130	140	150
Maximum Catchment Area per downpipe(m <sup>2</sup> )	104	84	70	60	52	46	42	38	35	32	30	28

#### Typhoon® Spouting system

Flow Capacity: 87 litres/minute  
Cross-sectional area: 6100 mm<sup>2</sup>

#### Maximum Roof Area per downpipe (m<sup>2</sup>)

Rainfall Intensity* (mm/hr)	40	50	60	70	80	90	100	110	120	130	140	150
Maximum Catchment Area per downpipe(m <sup>2</sup> )	131	105	87	75	65	58	52	48	44	40	37	35

#### RP80® 80mm round downpipe system

#### Maximum Roof Area per downpipe (m<sup>2</sup>)

Roof Pitch	Maximum Roof Area served per downpipe (m <sup>2</sup> )
0° – 25°	85
25° – 35°	70
35° – 45°	60
45° – 55°	50

NB: Based on average rainfall intensity of 100mm/hr

\* As per NZBC E1 – Surface Water, Rainfall Intensity equates to a 1 in 10 year storm and varies depending on geographic location. For example, 100mm/hr is a general rule of thumb for the Auckland region however please refer to [hirds.niwa.co.nz](http://hirds.niwa.co.nz) for current rainfall intensity specific to your location.

### 3.3 WET SYSTEM – HEAD PRESSURE

When downpipes are holding water for a prolonged period of time and are therefore subjected to head pressure (e.g. water tank connection or downpipe installed horizontally), ONLY round downpipes are suitable. Care should be taken to ensure that all joints are sealed properly using Marley MCS solvent. Marley does not recommend uPVC downpipes be buried, instead Stormwater/DWV pipe should be used for this application. Marley's downpipe to stormwater adaptors have been tested to 3.8m of head pressure.

NB: If using a Marley Curve leaf and debris diverter on a wet system, ensure the Curve is installed on the downpipe at least 300mm above the height of the tank's inlet point and overflow outlet.

### 3.4 FABRICATION

Marley's fabrication services can provide assistance with special part requirements for the completion of your project. Items, such as those described below, can be fabricated to the required dimensions:

- Special angle flat
- Special outlet
- Special angle rake
- Special adaptor

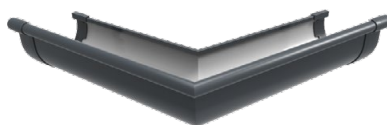

Special angle flat



Special angle rake

### 3.5 SNOW LOADING / WIND EFFECT

Marley recommends reducing the bracket spacing to 300mm for areas subjected to high wind or occasional snow falls. Where snow straps are required Marley recommends the use of snow straps that support the full external profile of the spouting system, attaching to the fascia under the base of the profile and then connecting to the roof according to the snow strap manufacturer's recommendations. This ensures the Marley uPVC spouting system can still accommodate thermal movement whilst providing additional support in case of heavy snow fall.

### 3.6 COLOUR DURABILITY

Over time the components of the Marley spouting and downpipe system will weather, as is customary with all exterior pigmented finishes. The colour weathering will not affect the long-term durability of the system. The rate at which the colour fading occurs will be dependent on the environmental conditions the product is exposed to, including UV levels, pollution and building orientation.

### 3.7 OVERFLOW ALLOWANCE

In the event of extreme rainfall or a blocked downpipe it is important to consider allowance for water overflow. All Marley spouting systems feature a high front face and maintain a 10mm gap between the back face of the gutter and the fascia board so that water is able to safely overflow over the back face without entering the internal envelope of the building.

This design approach is in accordance with the BRANZ Technical Bulletin 509 "Sizing Gutters and Downpipes" which in Section 4.0.1 states "**External gutters should be designed to allow water to spill to the exterior (usually between the back of the gutter and the fascia) should they overflow due to high rainfall or should a downpipe become blocked.**"

NB: The high front face of Marley spouting systems assist in preventing wind-blown rain entering the building envelope and help protect the roofing underside from salt-laden air. This is also recommended in BRANZ Technical Bulletin 509 – extract "**The front face of the gutter should be higher to restrict the potential for water being blown up under the bottom edge of the roofing – see Figure 2.**"

#### PLAN VIEW REPRESENTATION OF MARLEY SPOUTING SYSTEMS

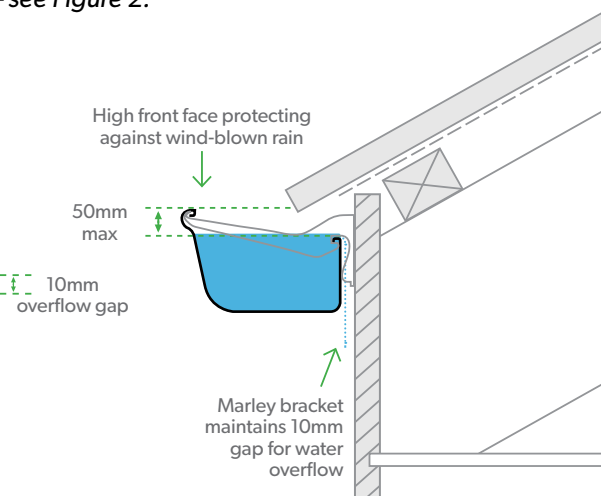
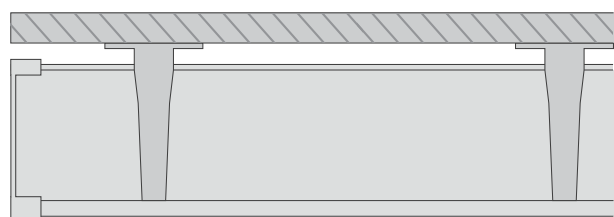

^ Refer to page 25 Maintenance Section for further detail.

## 4.0 INSTALLATION DETAILS

### 4.1 PLANNING & PREPARATION

Draw your roof plan to scale, or use roof plan details of your house if available. A scaled drawing enables spouting lengths, spouting brackets and other required components to be more easily estimated. Establish the following:

- downpipe locations
- thermal expansion relief points
- spouting and downpipe lengths required
- fittings required.

It is important to determine which direction the installation will be completed, as components should be solvent welded one after the other working in one direction.

- For a gable ended roof start fitting the spouting at the high point working towards the expansion outlet.
- For a hipped roof commence from a corner.

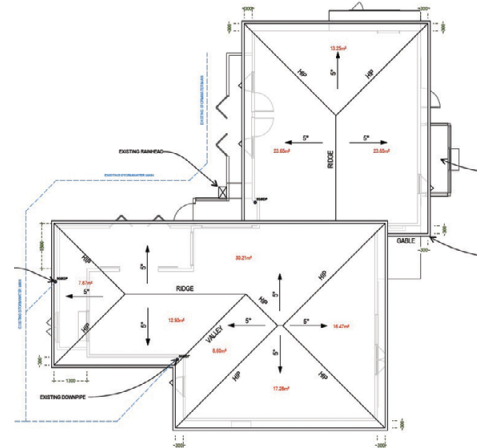

#### 4.1.1 Roof Overhang

The roof overhang should not be less than 50mm to ensure correct roof water discharge into the spouting.



**NB.** For the purposes of this design and installation guide, the Marley Typhoon® spouting system has been used to illustrate correct installation procedures. Where the installation requirements differ for the Marley Stormcloud® spouting system, this will be noted separately.

**STORMCLOUD®  
SPOUTING**

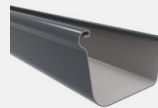

**TYPHOON®  
SPOUTING**

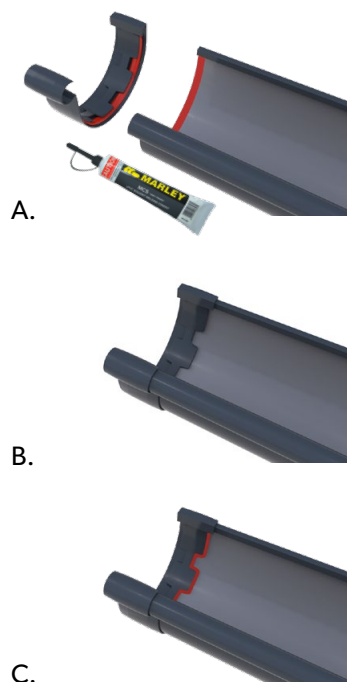
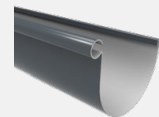

#### 4.1.2 Solvent Welding Procedure

Marley spouting and downpipe systems are assembled using solvent welding cement which ensures a watertight system and resistance to mechanical stress over the years.

1. Ensure cuts of the spouting profile are straight and clean.
2. The surface areas to be welded must be clean and dry before the solvent is applied.
3. Apply the appropriate colour matched Marley MCS® solvent welding cement evenly to both surfaces to be joined. (A)
4. Ensure that the spouting has been fully pushed until it stops. (B)
5. Apply a final bead of solvent to fully seal the assembly. (C)
6. Wait 10 minutes before manipulating the assembly.
7. Any surplus solvent on the exterior surface should be removed immediately with a clean cloth.

### 4.1.3 MANAGING THERMAL MOVEMENT

Marley uPVC systems expand and contract at a linear thermal expansion coefficient of 0.7mm /m /10°C. Marley spouting systems allow for the thermal expansion of uPVC using expansion outlets and expansion joiners, creating relief points for expansion during the install. It is best practice to default to an Expansion outlet as the downpipe dropper.



Expansion joiner (MT17)



Expansion outlet (MT8.80)

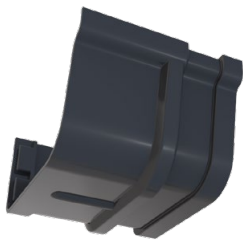

Expansion Joiner (MS17)



Expansion outlet (MS8.80)

### Controlling the direction of Thermal Expansion/Contraction

To address thermal expansion, consider each run of spouting separately. Through continued expansion and contraction over a period of time, certain spouting runs which lead from an expansion outlet, may gradually creep in one direction. This may cause it to drop out of the expansion outlet or move too far into the expansion outlet.

**This can be prevented by screwing the spouting onto the fascia as indicated in the diagrams below.**

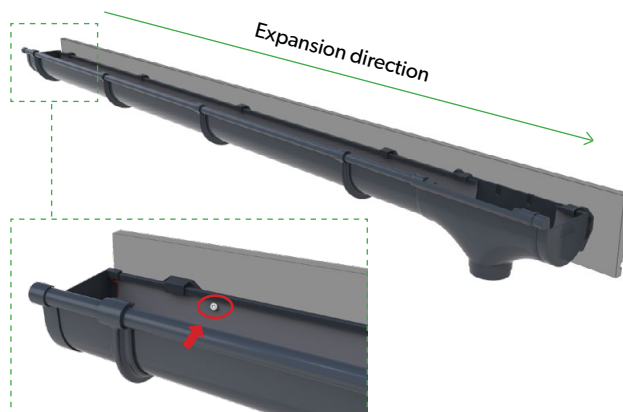

Screw spouting opposite end to expansion outlet (refer to 1A on following page)

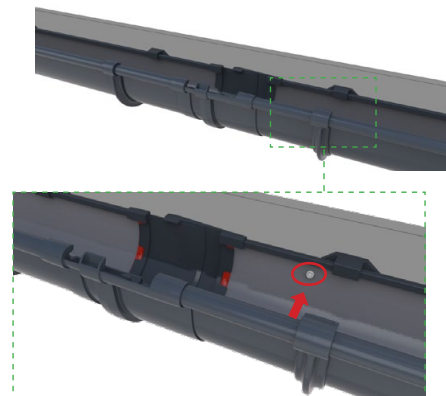

When expansion outlet and expansion joiner are used on the same run, also screw spouting adjacent to expansion joiner (refer to 2B on following page)

## Fixing spouting to the fascia

These diagrams illustrate where the spouting should be screwed to the fascia to control the direction of expansion, for a number of common scenarios.

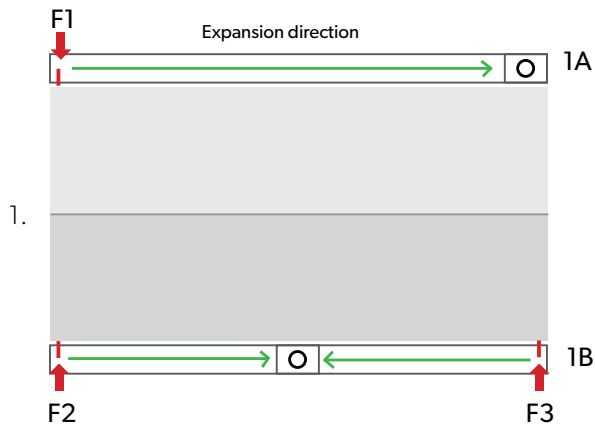

1A. For an expansion outlet positioned at one end of a spouting run, the expansion will be directed from the stop end to the expansion outlet.  
Fix at location F.

Maximum run length: 12m

1B. For an expansion outlet positioned in the middle of a spouting run, the expansion will be directed from the stop end to the expansion outlet.  
Fix at locations F2 and F3.

Maximum run length: 24m

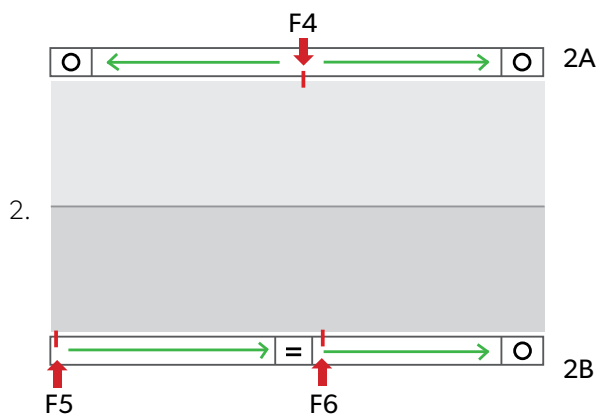

2A. For a long run of spouting with an expansion outlet at each end of the run, fix the spouting in the middle of the run to direct the expansion towards each outlet.  
Fix at location F4.

Maximum run length: 24m

2B. For a long run of spouting exceeding 12 metres with an expansion outlet at one end, an expansion joiner is also required. The spouting will require fixing on the expansion outlet side of the expansion joiner and at the end of the run. Fix at locations F5 and F6.

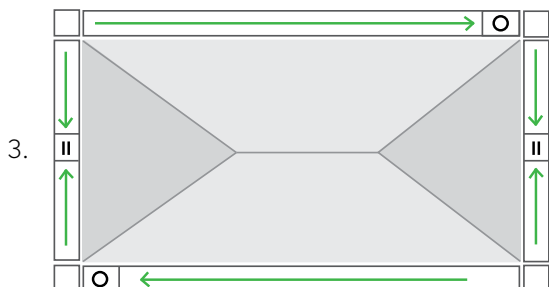

3. For a spouting run exceeding 4 metres between corners without an expansion outlet, an expansion joiner is required. In this instance, the spouting will not require screwing onto the fascia.

KEY:  Outlet  
 Expansion Joiner

NB. The maximum run length calculations provided above are based on the darkest Marley colours and the maximum temperature variance expected in New Zealand. Actual thermal movement will vary depending on the house location, design/orientation and the Marley colour chosen.

#### 4.1.4 Water Flow Direction – High Point To Low Point

First establish the low points of the installation. These are determined by the location of existing downpipes or storm water outlets and will become the outlet fixing points. Mark the centre of each outlet on the fascia board. High points should be half way between low points or with complex roofs try to establish the high points at the corners.

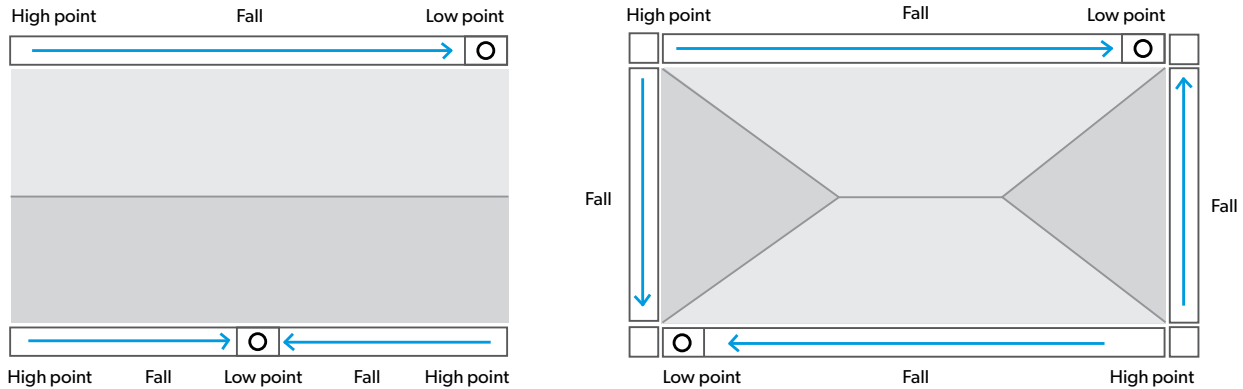

#### 4.1.5 Recommended Fall

The New Zealand Building Code E1/AS1 stipulates that spouting should always be installed with a fall to the outlet. Marley recommend a minimum fall to the outlet of 5mm per 10m (1:2000). This will ensure water travels efficiently to the downpipes and ponding is avoided.

### 4.2 STORMCLOUD / TYPHOON SPOUTING INSTALLATION

#### 4.2.1 Bracket Positioning

Brackets must be secured to the fascia with a maximum spacing of 500mm. In high wind areas or regions prone to occasional snow fall, reduce spacing to 300mm. **The system is NOT recommended for HEAVY snow fall areas.**

GENERAL: Position the first bracket at the determined high point as high as possible under the roof over-hang. Run the string line under the bottom of the first bracket to the very end of the run, allowing the recommended fall of 5mm per 10m. Repeat this operation for each run always working from high point to low point.

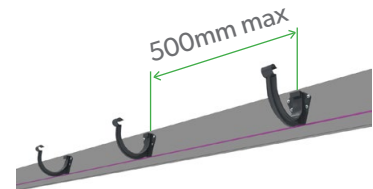

EXTERNAL CORNER (MT6/MS6): For an external corner allow 50mm clearance from the fascia to the centre of the first bracket.

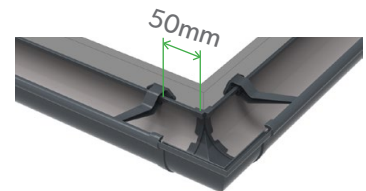

INTERNAL CORNER (MT7/MS7): For an internal corner allow 200mm clearance.

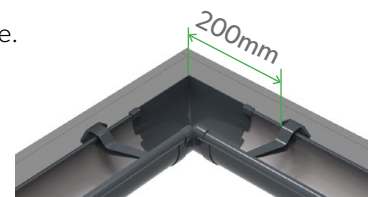

EXPANSION OUTLET (MT8.80/MS8.80/MS8.65): Position the first bracket 250mm from the centre of the expansion outlet.

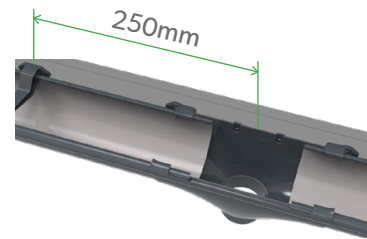

EXPANSION JOINER (MT17/MS17): For expansion joiner, allow a spacing of 300mm (about the centre) between the two brackets.

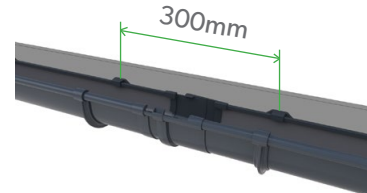

The plan view below is indicative of a typical installation showing recommended bracket spacing for the individual components detailed above.

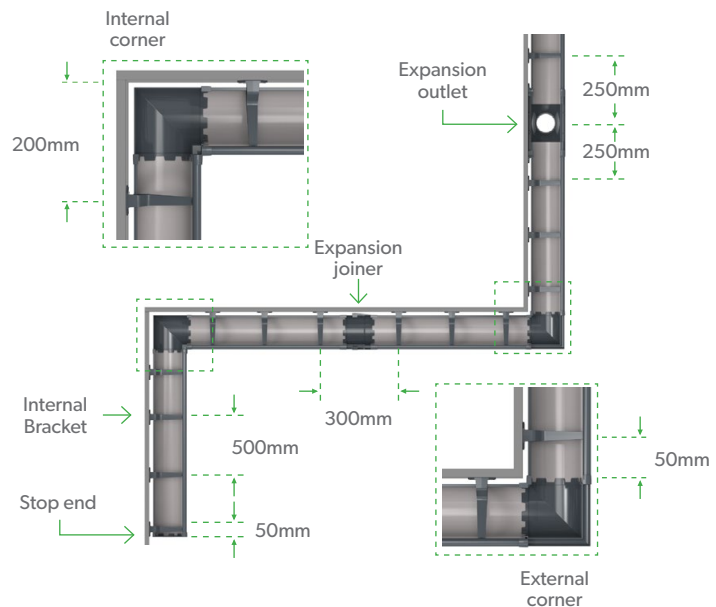

#### 4.2.2 Bracket Fixing

Use a minimum of 3 fixings per bracket, ensuring both top holes are used.

##### On timber fascia;

- Self tapping screws 6g x 20mm Pan Head or Wafer head

##### On metal fascia;

- Marley® SCREW.METAL (M4 20mm S/S 410 BLK)



To ensure the right selection of fixings material grade for your project, refer to a specialist fastener manufacturer for advice.

### 4.2.3 Installing the expansion outlet (mt8.80/ms8.80/ms8.65)

1. Set up the string line as per Section 4.2.1 on page 14 so that the bottom edge of the spouting brackets are aligned with the string line.
2. Mark the position of the expansion outlet on the fascia.
3. Fix the expansion outlet to the fascia using the side fixing tabs to align with the string line.

**NB. A minimum of 4 fixings should be used to attach the expansion outlet to the fascia.**

#### INTERNAL BRACKETS

- (a) When using internal brackets (MT2I/MS2) align string line with "INTERNAL" marking on side fixing tab of the outlet.

**NB. For internal brackets the side fixing tabs can be cut at the "Trim" line so the tabs aren't visible after the spouting is installed.**

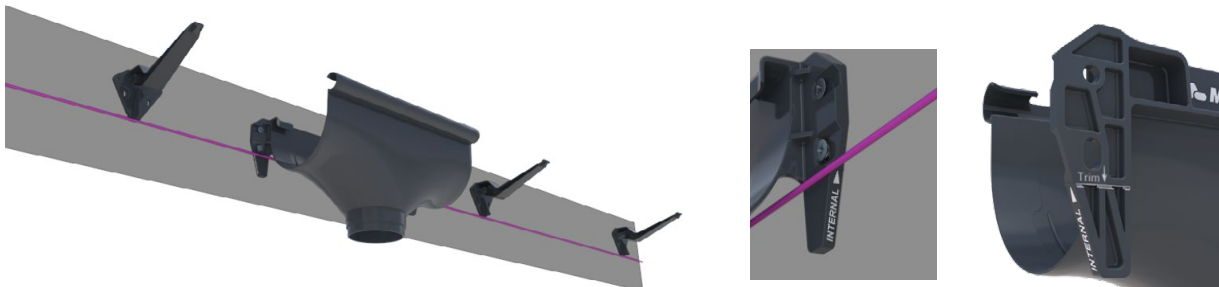

#### EXTERNAL BRACKETS (TYPHOON SYSTEM ONLY)

- (b) When using external brackets (MT2E) align the string line with "EXTERNAL" marking on the side fixing tab of the outlet.

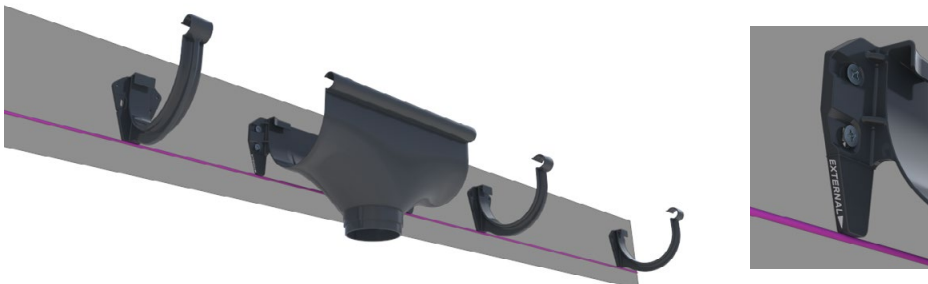

### 4.2.4 Inserting the spouting into the brackets

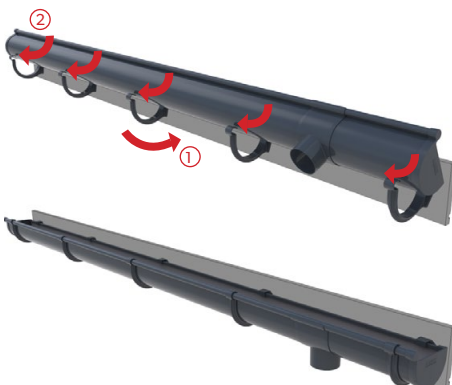

With External Bracket (MT2E)

1. Engage the back of the spouting into the rear of the bracket in order to clip it in position.
2. Then one by one clip the front hook of the spouting into the tip of brackets.
3. Check every bracket is correctly engaged.

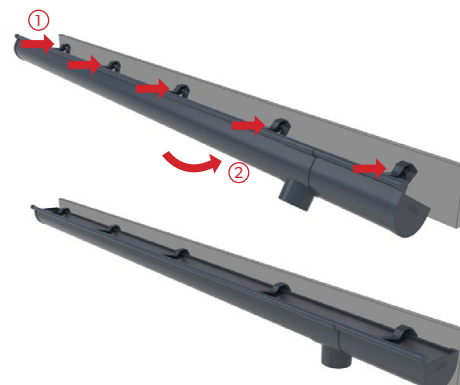

With Internal Bracket (MT2I/MS2)

1. Position the front hook of the spouting onto the tips of the brackets and one by one clip it into position.
2. Engage the back of the spouting into the rear of the bracket in order to clip it in position.
3. Check every bracket is correctly engaged.



#### 4.2.5 Inserting the spouting into the expansion outlet

The spouting is **not solvent welded** to the expansion outlet. Instead it is clipped in to allow the spouting to expand and contract freely.

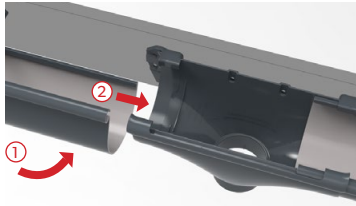

1. Clip spouting into bracket and slide into position.



2. Ensure the end of the spouting is aligned with the marking corresponding to the air temperature at the time of installation.



3. This will ensure correct movement of the spouting during thermal expansion.

#### 4.2.6 Installing the stop end to an expansion outlet

##### Typhoon® Spouting System

The stop ends (MT3) and (MT4) do not fit directly onto the expansion outlet. Please follow the below instructions to fit a stop end onto an expansion outlet.

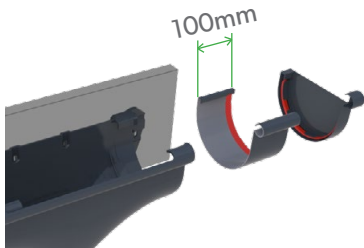

1. Cut 100mm section of spouting and solvent cement the stop end to one end of the spouting.

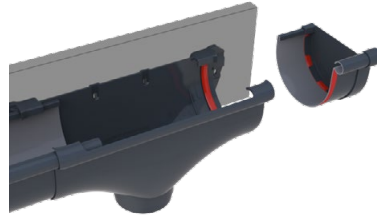

2. Solvent cement the sub-assembly to the expansion outlet as shown.

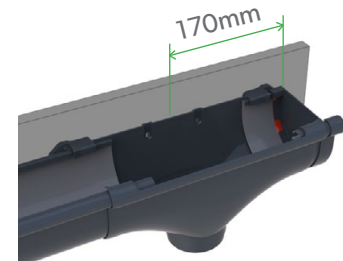

3. Assembly is complete.

##### Stormcloud® Spouting System

The stop ends (MS3/MS4) fit directly onto the expansion outlet. Please follow the instructions below to fit a stop-end onto an expansion outlet.

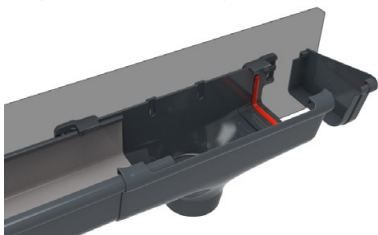

1. Solvent cement both the expansion outlet and the stop end and then connect together.

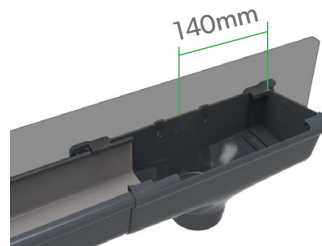

2. Assembly is complete.

#### 4.2.7 Expansion joiner setup (MT17/MS17)

When an expansion joiner is used it should be pre-adjusted to the corresponding air temperature mark at the time of installation. This will ensure correct movement of the spouting during thermal expansion and contraction.

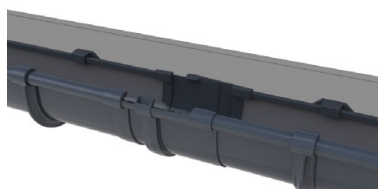

Temperature graduations

### 4.3 SPOUTING INSTALLATION SCENARIOS

This section illustrates the key steps in installing common spouting runs. The three scenarios are shown complete below then detailed in steps on the following pages.

#### SCENARIO 1 (detail on page 19)

##### 4.3.1 Spouting run to an expansion outlet

A linear run of spouting terminating with an expansion outlet.



#### SCENARIO 2 (detail on page 20)

##### 4.3.2 Spouting run with an expansion joiner

A linear run of spouting with an expansion joiner part way the run.



#### SCENARIO 3 (detail on page 21)

##### 4.3.3 Spouting Run To Dropper Outlet

A linear run of spouting terminating with a dropper outlet. NOT to exceed four metres in total length.



## SCENARIO 1

### 4.3.4 Spouting run to an expansion outlet

1. Fix the brackets to the fascia with the correct spacing from high point to low point (refer to Section 4.2.1 on page 14 for recommended bracket positioning). Use the recommended fall to the outlet of 5mm per 10 metres.

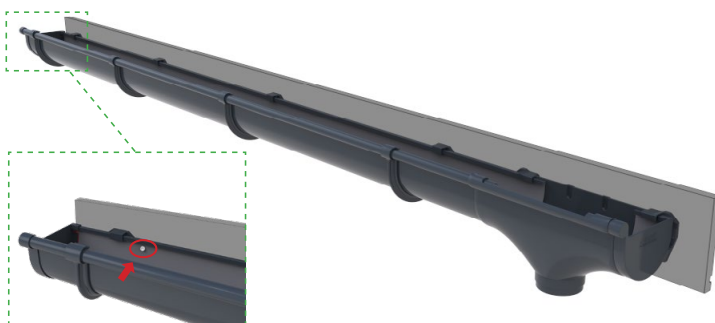
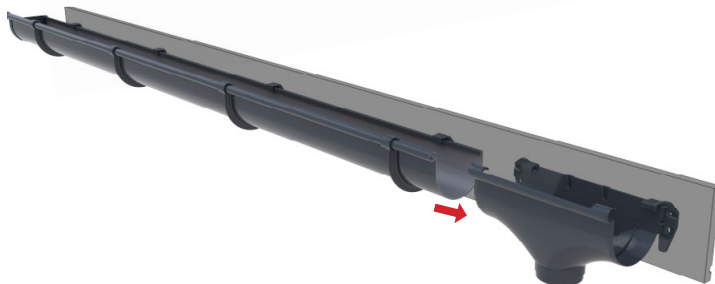
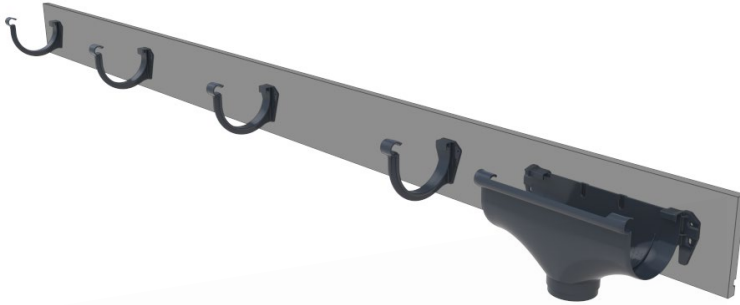

2. Fix the expansion outlet. If terminating the run, refer to Section 4.2.6 page 17 for stop end installation.

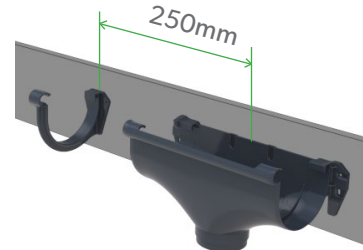

3. At ground level solvent weld the stop end onto a spouting length. Let this assembly set for at least 10 minutes.

4. Once the solvent is set, insert the length of spouting into the brackets and slide into the expansion outlet. Align end of spouting to marking corresponding to the air temperature at the time of install.

5. **Screw spouting opposite end to expansion outlet** (refer to 1A page 13).  
The run is complete.

## SCENARIO 2

### 4.3.5. Spouting run with an expansion joiner

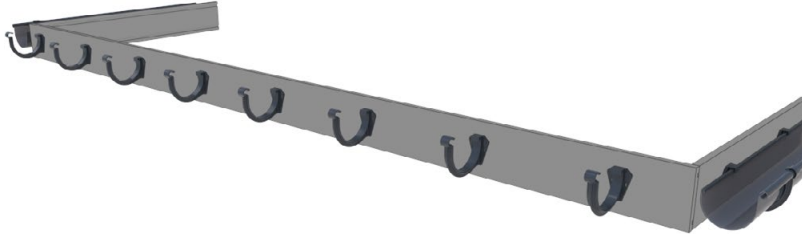

1. Fix the brackets to the fascia with correct spacing from high point to low point (refer to Section 4.2.1 on page 14). Use the recommended fall to the outlet of 5mm per 10 metres.



2. At ground level solvent weld the external angle and expansion joiner onto a spouting length. Let this assembly set for at least 10 minutes.

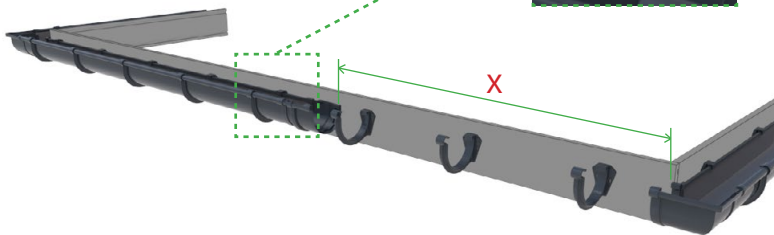

3. Once the solvent is set, insert the length of spouting into the brackets.
4. Adjust the expansion joiner to the corresponding temperature mark at the time of install and then measure the spouting length X required between the expansion joiner and the next corner.
5. Cut the required length of spouting using a fine tooth saw or drop saw.



6. Position the remaining length of spouting onto the brackets.
7. Solvent weld the length to the expansion joiner and then to the external angle.
8. The run is complete.

## SCENARIO 3

### 4.3.6 Spouting run with a dropper outlet

NOTE: The run should not exceed 4 metres when using a dropper outlet (MT11.80 or MC11.80) unless other expansion allowance has been made i.e. use of an expansion joiner. Alternatively, for longer runs, use an expansion outlet (MT8.80, MS8.80 or MS8.65). See section 4.1.3 page 12 Managing Thermal Movement.

#### Typhoon® Spouting System (MT11.80)

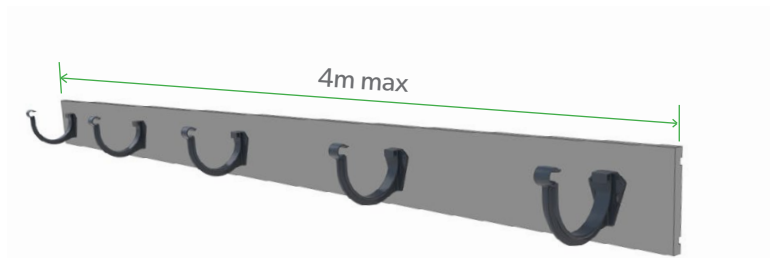

1. Fix the brackets to the fascia with correct spacing from high point to low point (refer to Section 4.2.1 on page 14). Use the recommended fall to the outlet of 5mm per 10 metres.
2. Measure the spouting length required for the run. Allow some clearance for thermal expansion if the run is installed between barge boards.



3. At ground level solvent weld on the two stop ends.
4. Place the dropper outlet onto the spouting and mark the position of the hole to be cut.
5. Use an 80mm hole cut saw to drill the bottom of the spouting. Note: A bracket can be positioned either side of the hole to support the spouting during cutting.
6. Apply Marley MCS solvent cement to both surfaces to be joined and weld into position **on the outside of the spouting length.**
7. Assembly is complete.  
NB. Wait 10 minutes before manipulating the assembly.

#### Stormcloud® Spouting System (MC11.80)

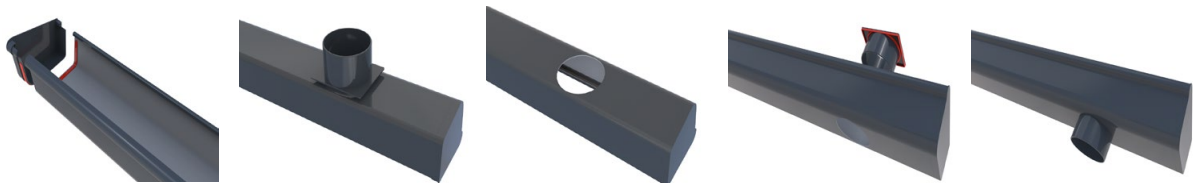

1. At ground level solvent weld on the stop ends.
2. Place the dropper onto the bottom of the spouting and mark the position of the hole to be cut.
3. Use an 80mm hole cut saw to drill the bottom of the spouting.  
NB. A bracket can be positioned either side of the hole to support the spouting during cutting.
4. Apply Marley MCS solvent cement to the underside of the dropper as indicated and insert into hole from above, **on the inside of the spouting length.**
5. Assembly is complete.  
NB. Wait 10 minutes before manipulating the assembly.

NOTE: Marley's MC11.80 dropper can be used to easily connect Marley RP80 downpipe to a metal spouting system. Use a quality waterproof exterior sealant instead of Marley MCS to secure the dropper.

## 4.4 RP80® 80MM ROUND DOWNPIPE INSTALLATION

### 4.4.1 Soffit offset assembly

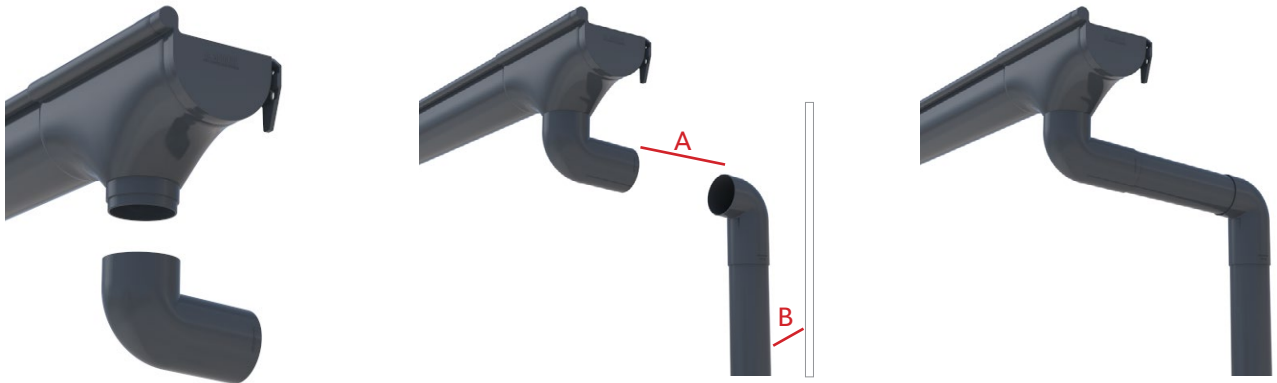

1. Connect the first bend to the expansion outlet. Note: For easy removal of the downpipe assembly for future cleaning and maintenance, screw rather than solvent weld the first bend to the outlet.
2. Calculate the offset length. When calculating the length of offset downpipe (A), include the length of sockets (30mm or 40mm each end depending on bends used and orientation) and take into account the gap (B) between the downpipe and the wall. (Refer Section 4.4.4 for downpipe clip dimensions).
3. Solvent weld the offset length of downpipe to the first bend and then solvent weld the second bend.

### 4.4.2 Downpipe joiner (RS80)

A downpipe joiner (RS80) is required to connect two lengths of downpipe.



Use solvent welding cement to secure the joiner onto the downpipes.



### 4.4.3 Direct connection of RP80® to outlet

The tiered outlet connection allows non-socketed pipe to directly connect to the outlet.

Note: For easy removal of the downpipe assembly for future cleaning and maintenance, **screw rather than solvent weld** to the outlet.

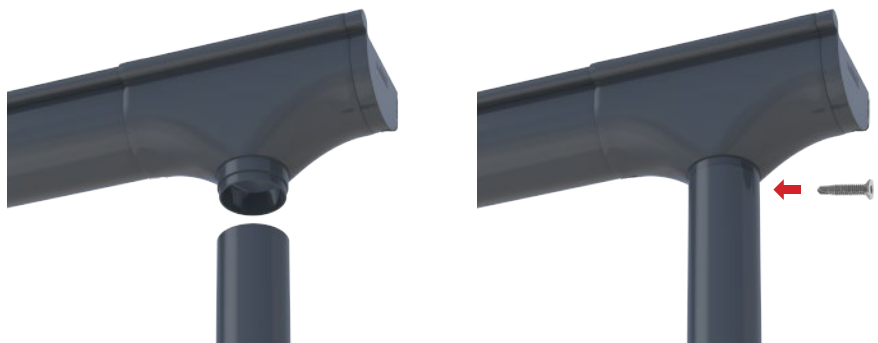

#### 4.4.4 Installing downpipe clips (RC80, RC80.2 & RC80.2S)

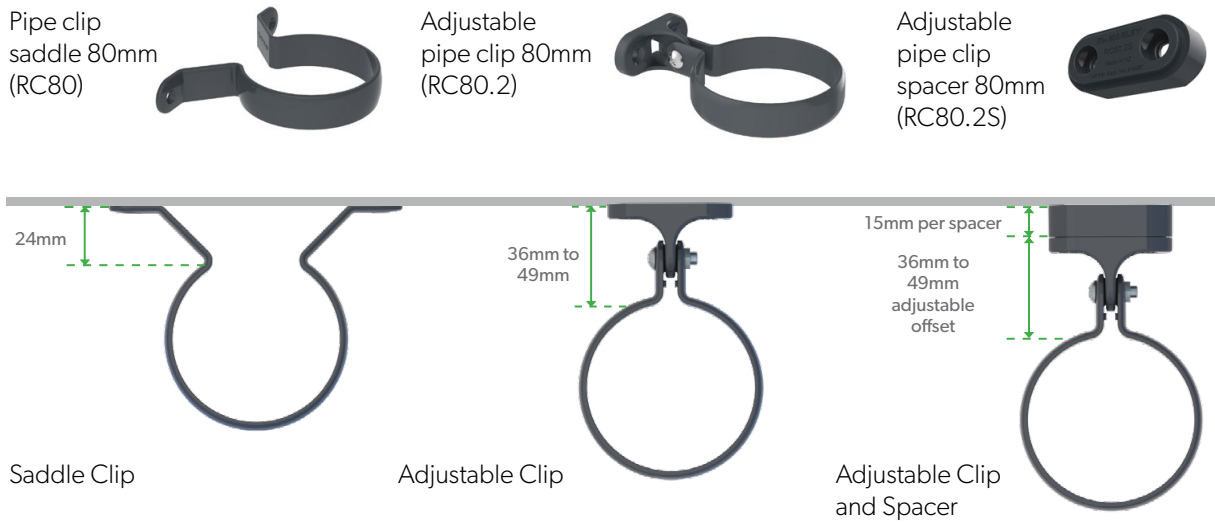

#### Vertical Installation



1. Use a level or plumb line to mark the downpipe position against the wall. Dry assemble the downpipe and mark the positioning of the downpipe clips.
2. Place the first downpipe clip to a maximum of 200mm from the second bend using two stainless steel screws. Ensure the second and further clips are spaced no more than 1.2 metres apart.
3. Assembly is complete.

#### Horizontal Installation

Place the first downpipe clip no more than 200mm from the bend or junction. Ensure the second and subsequent clips are no more than 1.0m apart. Note that horizontal downpipe should never be installed without a fall away from the spouting. Using a RB2.80 95° bend or correctly orientated R|80 95° junction will help ensure a fall as these components have a shallow downward angle built into them.

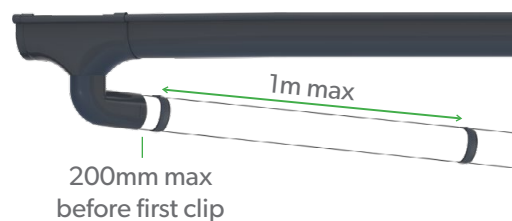

#### 4.4.5 Installing the downpipe junction (RJ80)

The downpipe junction (RJ80) is used to connect a downpipe discharging from an outlet into another downpipe.

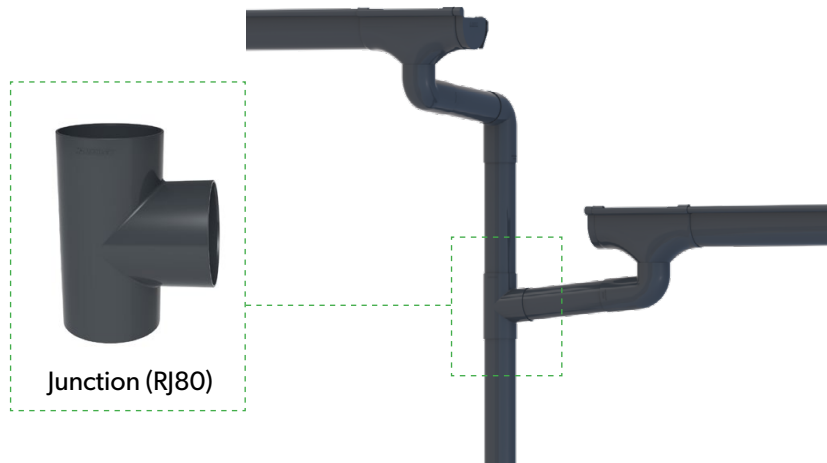

#### 4.4.6 Downpipe to stormwater connection

Marley has a range of adaptors to connect directly between Marley RP80® 80mm round downpipes and Marley Stormline® 90mm or 100mm stormwater pipes. This is of particular use for 'wet' or charged systems where the homeowner is collecting rainwater. Available in all colours from the Marley Stratus Design Series® the adaptors provide a water-tight professional colour matched solution.



RA80.90



RA80.100

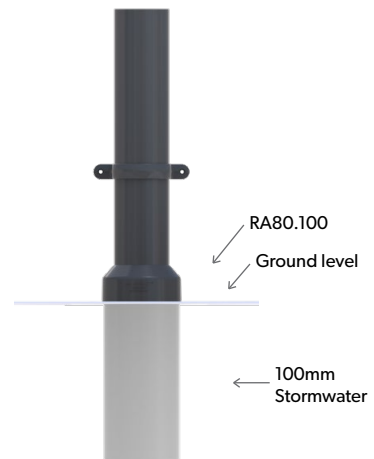

#### 4.4.7 Downpipe spreader kit (SKIT80)

The spreader allows for the even distribution of water to a lower level roof. It assists in complying with the Building Code E2/AS1. The relevant extract is below.

*Building Code E2: external Moisture / 8.0 Roof claddings / 8.1.6 Spoutings. Downpipes discharging to a lower roof shall be fitted with a spreader as detailed in Figure 20 below, with the discharge limited to a section of roofing with no side laps. Spreader shall not be used on masonry tile roofs unless a roof underlay is installed. A maximum catchment area of 25m<sup>2</sup> shall be permitted to discharge via a spreader onto a lower roof area.*

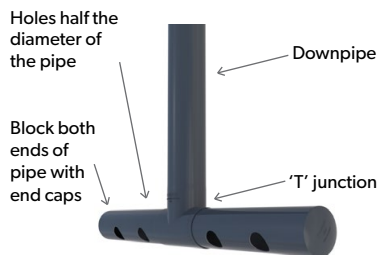
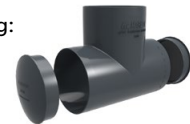

Figure 20

Marley's spreader kit includes the following:

- 1 x 80mm 90° tee junction
- 2 x end caps 80mm
- Fixings and installation instructions.



1. Hole positions to avoid joints in roofing.
2. When downpipe is located in corner, spreader to be L-shaped.
3. Position holes to feed into roofing troughs and angled 45° down to roof.



#### 4.4.8 Curve® Leaf Diverter

The Curve is a leaf and debris diverter featuring Marley's own innovative filtering technology. Quick and easy to install, it helps improve the quality of water for tank users and helps reduce the risk of blockage or overflow for those on stormwater systems.

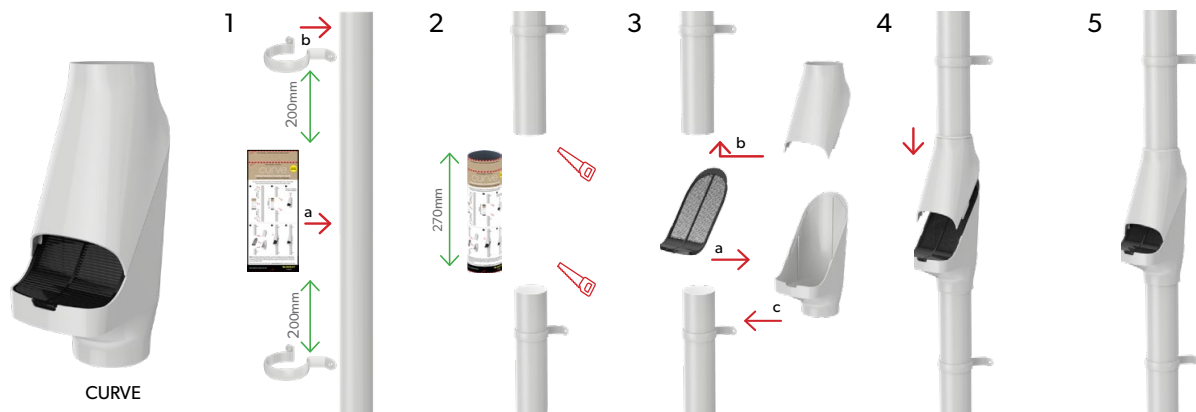

#### 4.4.9 Twist® Rainwater Diverter

Urban intensification, rising costs and environmental concerns make the collection of rainwater increasingly important. Twist direct connects via a standard hose fitting to a collection tank such as Marley's Tank-It, providing a free water source for watering, cleaning or emergency supply.

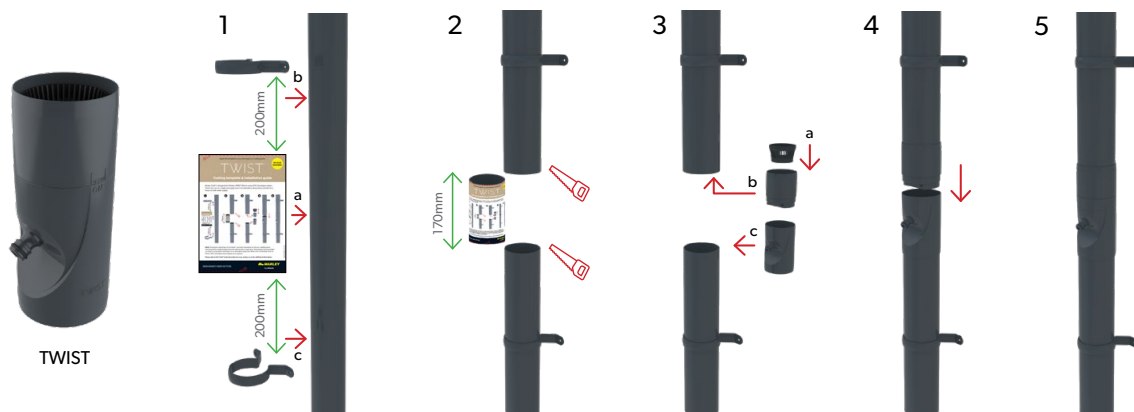

### 5.0 MAINTENANCE AND HANDLING

#### 5.1 MAINTENANCE

To ensure the Marley spouting and downpipe system maintains its performance and appearance:

- Regularly clear the inside of the spouting of leaves, silt, or other debris that can obstruct the flow of water and create additional load on the brackets and joints. This will prolong the life cycle and ensure full performance of the system.
- Water overflow is often the result of outlet blockages so it is recommended they are clear of debris at all times. The use of a Marley outlet strainer (RWST) is recommended to prevent large debris from entering the downpipe.
- Expansion joiners are designed with an EDPM rubber seal creating water tightness between the two sliding parts of the joint. Over time the lubricated rubber seal may lose its sliding capability and this can be resolved by unclipping the joiner, cleaning the seal and lubricating it with a silicone based lubricant before reassembling.
- To maintain the appearance of the system the exterior of the spouting can be washed at least once per year using warm soapy water and a soft bristled brush or cloth. Simply rinse off with clean water.



## 5.2 TOUCH UP PAINT

Marley does not recommend the use of touch-up paint for its range of co-extruded uPVC coloured systems. Air drying touch-up paints have different weathering characteristics to co-extruded uPVC coloured systems. Over time, the touch up paint will fade at a different rate to the co-extruded uPVC coloured systems, producing an unacceptable aesthetic appearance.

Please take the following into consideration when assessing scratches and marks:

- If the scratches are obvious and visible from two metres away then the spouting, downpipe or fitting should be replaced.
- Minor surface scratches or marks become less noticeable as the external co-extruded layer weathers and are best left as they do not affect the long-term durability of the Marley uPVC spouting and downpipe system.
- Rough handling of the components before and during the installation should be avoided as repainting is not an option and replacement of the damaged components will be required.

## 5.3 STORAGE

If storing Marley uPVC spouting and downpipe systems for a long period of time, the product should be kept in its original polyethylene sleeving and the fittings kept in their original bags or cartons. Both should be stored inside a building, out of direct sunlight to reduce the heat exposure whilst inside packaging.

Furthermore:

- Profiles should be well supported and stored on a flat surface to avoid deformation. Avoid stacking too many bundle packs to prevent overloading. A maximum of four packs high is recommended.
- Fittings supplied in cartons should be stored under cover in a cool dry place and remain packed until required for installation.
- Solvent welding MCS must be securely stored in a cool place, out of direct sunlight and away from any heat source.

If the only option is to store the spouting and downpipe for long periods in strong sunlight, they should also be covered with a light coloured opaque sheet.

## 5.4 HANDLING

Marley uPVC spouting and downpipe systems are strong, lightweight and therefore easy to handle. Both spouting and downpipes are packed into strong polyethylene sleeving to prevent damage during transport and storage. When carrying bundle packs ensure they are lifted clear of the ground to avoid dragging, which could damage the ends of the product. When removing lengths from the sleeving, check that the external surface is facing up and handle with care.

During installation, handle the lengths with care to avoid damage to the exterior. To preserve the appearance of the profiles and fittings, when products are delivered to site, or left on the building site for a long period of time, they should be placed inside a storage building out of direct sunlight. All products should be left in their original packaging until ready to install on the building. If installation is to be carried out during extremely cold conditions, additional care should be given when handling the products.

Any product over 25 kilos needs to be lifted mechanically.

### Downpipe

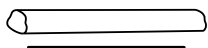

Store on flat surface



Store out of direct sunlight

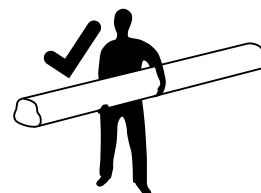

Handle with care  
Lift, don't drag

### Spouting



Store on flat surface



Store out of direct sunlight

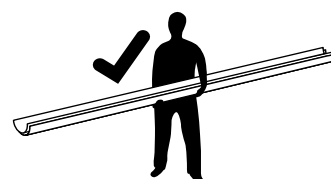

Handle with care  
Lift, don't drag

## 6.0 GUARANTEE

Marley New Zealand Limited (Marley) guarantees the purchaser of Marley spouting, downpipe or rain harvesting products (Products) against defects in material and manufacture (Guarantee) for a period of 15 years from the original date of purchase (Guaranteed Period).



**Conditions:** This Guarantee is subject to the following conditions:

- The Products must be used only externally to the building envelope and are not suitable for use as a concealed system.
- The Products must be used and installed strictly according to the then current Marley published installation instructions as at the original date of purchase.
- If the Products are to be used in any application not covered by the then current Marley literature as at the original date of purchase, written confirmation of suitability must be obtained from Marley and a copy provided to Marley with any claim made under this Guarantee.
- Only use Marley MCS Solvent cement to join uPVC fittings to uPVC spouting and downpipe to ensure the integrity of the completed system.\*
- The Products must be maintained in accordance with the then current maintenance program available in Marley's Rainwater literature at the original date of purchase.

Failure to meet all the conditions set out above will deem this Guarantee invalid.

**Exclusions:** This Guarantee does not apply to:

- Any colour fading of the Products, including any colour fading caused by environmental conditions. Over time the Products will weather, as is customary with all exterior pigmented finishes. The rate at which fading occurs will be dependent on the environmental conditions the Product is exposed to, including UV levels, pollution and building orientation.
- Any Products modified, repaired or interfered with in any way other than by Marley or a Marley authorised person.
- Any Products purchased for the purposes of a business under the Consumer Guarantees Act 1993.
- Any defects in the Products caused by or resulting from causes not attributable to faulty material or manufacture, including defects caused by or resulting from any act or omission by the purchaser including misuse, neglect, incorrect installation or accidental damage.

### Procedure

- **Subject to the conditions and exclusions above, if during the Guaranteed Period you consider that our Guarantee has not been fulfilled, do not attempt repairs or replacement.**
- **Contact Marley with your claim in writing, with proof of purchase and evidence of the original purchase date. Marley will then recommend an appropriate course of action.**

### Scope of the guarantee

- Subject to the conditions and exclusions above and provided that any claim is made within the Guaranteed Period, if any Products supplied breach this Guarantee, we will, at our option, provide replacement Product or refund the Product's original purchase price.
- This Guarantee is given to "consumers" as defined in, and who have the rights under, the Consumer Guarantees Act 1993 and should be read with the statutory consumer guarantees contained in that Act. This Guarantee is not intended to exclude, restrict or modify a consumer's rights under the Consumer Guarantees Act 1993.
- There may be some colour variation between existing Product and new Product supplied for replacement. Marley do not guarantee that any replacement Product will be an exact colour match to the original Product.
- Nothing expressed or implied in this Guarantee will confer any liability on Marley for any indirect, consequential or special loss or damage directly or indirectly resulting from any breach of this Guarantee.

## Sustainable Manufacturing

Marley is committed to creating environmentally sustainable processes and products and was the first plastics manufacturer in New Zealand to achieve ISO14001 registration. We are also Best Environmental Practice certified for our entire range of manufactured uPVC systems. This means we get our raw materials from sustainable and responsible sources, continuously work on our manufacturing processes to reduce our environmental footprint and accept our products back at the end of their useful life for recycling.

### BEST ENVIRONMENTAL PRACTICE



AS/NZS 5395: 2024  
LICENSE No 2969



### Disclaimer

This technical catalogue has been compiled by Marley New Zealand Limited ("The Company") to promote better understanding of the technical aspects of the Company's products to assist users in obtaining from them the best possible performance. The technical catalogue is supplied subject to acknowledgment of the following conditions:

The technical catalogue is protected by Copyright and may not be copied or reproduced in any form or by any means in whole or in part without prior consent in writing by the Company. Product specifications, usage data and advisory information may change from time to time with advances in research and field experience. The Company reserves the right to make such changes at any time without notice. Correct usage of the Company's products involve engineering judgements which cannot be properly made without full knowledge of all the conditions pertaining to each specific installation. The Company expressly disclaims all and any liability to any person whether supplied with this publication or not in respect of anything and of the consequences of anything done or omitted to be done by any such person in reliance whether whole or partial upon the whole or any part of the contents of this publication. No offer to trade, nor any conditions of trading, are expressed or implied by the issue or content of this manual. Nothing herein shall override the Company's Conditions of Sale, which may be obtained from the Registered Office or any Sales Office of the Company. This technical catalogue is and shall remain the property of the Company, and shall be surrendered on demand to the Company. Actual colours may vary slightly from those shown. For a more accurate colour comparison, please request a product sample.

## Our Partners



For more information: 0800 MARLEY (0800 627539) | [www.marley.co.nz](http://www.marley.co.nz)