



RP80[®]

80mm Round Downpipe System

STREAMLINED SIMPLICITY



15 YEAR
GUARANTEE



WILL NOT
RUST



U.V
RESISTANT



MADE
IN NZ



SAFE FOR
DRINKING



LOW
MAINTENANCE



100%
RECYCLABLE

 **MARLEY**

by aliaxis

Marley RP80®

80mm Round Downpipe System

The Marley RP80 80mm round downpipe system has set the standard in New Zealand for over 50 years, efficiently transferring rainwater from spouting to stormwater systems.

A streamlined look has been developed with an easy-care gloss finish, compact curves and concealed sockets. This fresh approach gives the system a modern appeal and incorporates innovative new components that make the Marley RP80 system even faster and easier to install.

Versatility

An extensive range of carefully colour matched injection moulded fittings ensure a consistent high quality finish, minimise cutting and simplify even the most complex installations. The whole system is available in a range of colours or can be painted to match the roof, cladding or the general colour scheme of the home.

The RP80 system can be used with any of Marley's residential range of uPVC spouting and is also compatible with metal spouting options.

Keeping New Zealand Green

The Marley RP80 80mm round downpipe system is certified for use with drinking water (AS/NZS 4020) and can be used with Marley rainwater accessories to help prevent debris from blocking drains or direct rainwater into storage for re-use.

The entire system is also 100% recyclable, BEP-certified and made locally in New Zealand further reducing the environmental impact.

Tough and Long Lasting

Marley's complete RP80 downpipe system is manufactured from uPVC. It is an extremely tough and long-lasting material that will not rust, dent or pop and requires little maintenance. UV resistant, all RP80 components come with a 15-year guarantee.

Colour Availability

The Marley RP80 80mm round downpipe system is available in the full designer range of Stratus Design Series® colours.

STRATUS®
DESIGN SERIES

**Scan to view the
colour range**

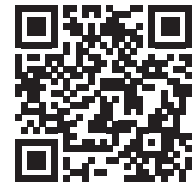

RP80 Downpipe

- Easy care gloss finish
- Smooth internal bore to aid flow
- 3m lengths for easy transport
- Impact and UV resistance
- NB white downpipe lengths are socketed at one end, Stratus coloured downpipe is unsocketed

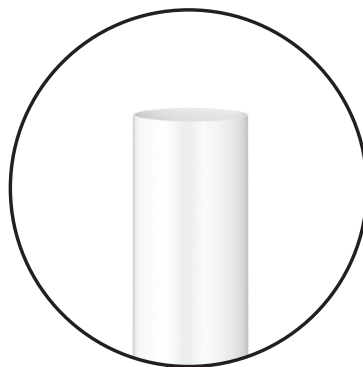

Superior Fittings

RP80 Bends

- Range of 95° and 43° Bends with compact options
- Concealed tapered sockets and smooth curves
- Easily navigate short transitions down to 44mm
- Over-insertion safety stop on all sockets
- Improved flow characteristics
- Nominal 90° and 45° angles for simple transitions

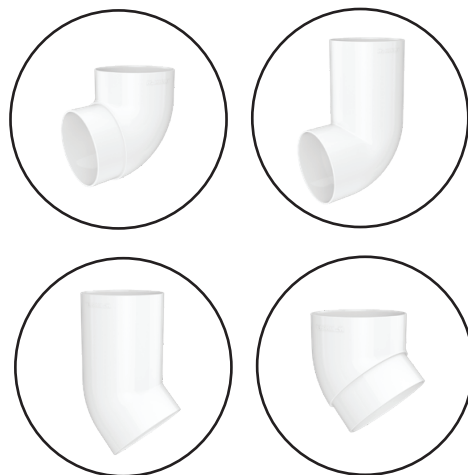

Common Installation Scenarios

Traditional eaves spouting

The standard 95° or 43° bends achieve an outlet to wall transition with clean lines and minimal effort. Use RB3.80's for increased flow.

A] RB2.80 + RB2.80

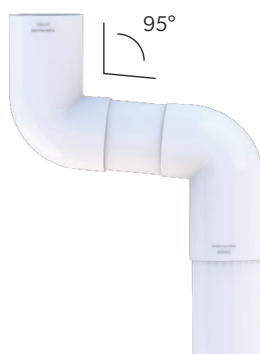

B] RB3.80 + RB3.80

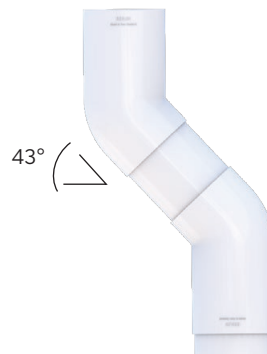

Narrow soffit

Combining the standard and compact bends allows a transition from outlet to wall using as little as 44mm without cutting or custom fabrication.

A] RB2.80 + RB4.80

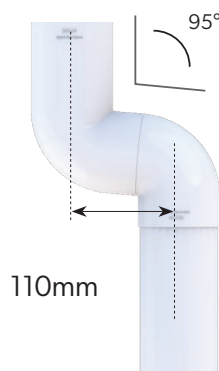

B] RB3.80 + RB5.80

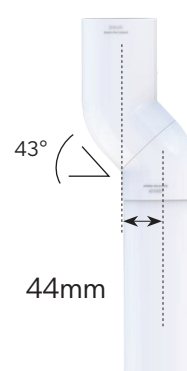

Stormwater outlet

Stormwater outlets that are out of alignment are easy to connect with Marley's new RP80 compact bends.

A] RB3.80 + RB5.80

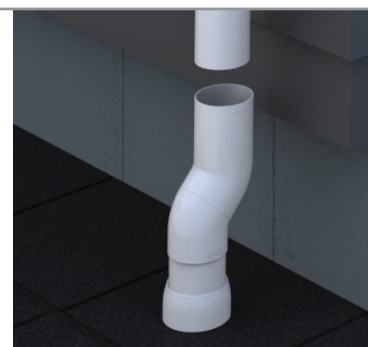

Superior Fittings

RP80 Clips

- Streamlined aesthetic
- Versatility to use with a variety of wall claddings
- Strong and flexible design
- Patented pipe clip spacer allows easy horizontal spacing
- Date of manufacture stamp on both clips



RC80

Saddle Clip

- Fast installation
- Strong and flexible support



RC80.2

Adjustable Clip

- 180° vertical angular adjustment - ideal for weatherboard
- Horizontal adjustment
- Retained SS 316 nut/bolt system



RC80.2S

Adjustable Clip Spacer

- Used with adjustable pipe clips
- Unique interlocking design*
- Allows easy horizontal spacing (15mm per spacer)
- Sold separately

Common Installation Scenarios

Horizontal off-set

The RP80 clip systems provide simple flexible solutions to off-set the downpipe from the wall. The saddle clip features a standard 24mm offset while the adjustable clip and spacer system allows for a custom offset to suit your particular situation. This is often useful with multi-storey houses that feature variations in cladding material or garages with little or no soffit.

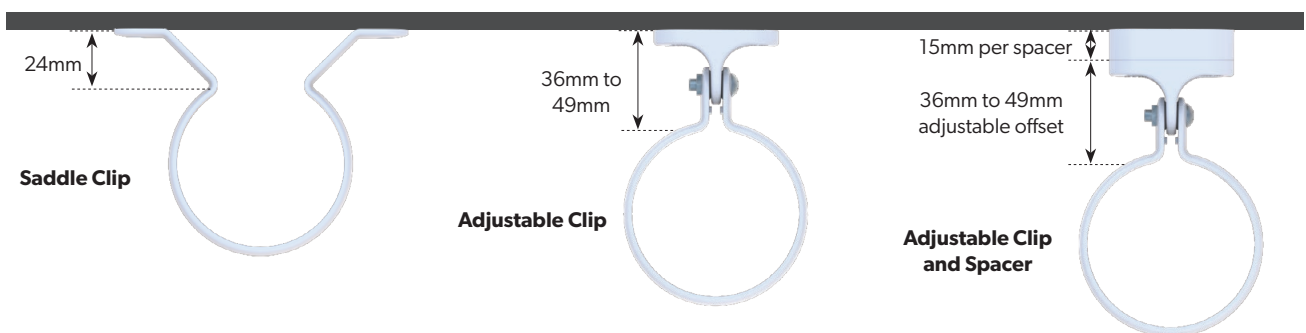

Angled cladding systems

The RC80.2 adjustable clip features 180° angular adjustment to fit your RP80 downpipe to any angled wall cladding surface such as weatherboard systems.

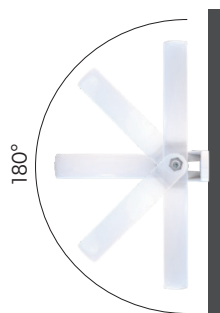

RP80 Joiner and Junction

- Clean lines and concealed tapered sockets
- Strong yet subtle connections
- Over-insertion safety stop on all sockets
- Standardised 'female' connections
- Use joiner as a female adaptor with M+F bends



Common Installation Scenarios

Joining two sections of RP80 downpipe

Fast, strong and simple connection achieved with minimal effort. The RS80 joiner is a versatile fitting that can also connect directly to outlets or droppers to provide vertical extension for deep fascias or for non-socketed downpipe connections where no soffit exists.



Creating an RP80 downpipe junction

The RJ80 junction connects a downpipe discharging from an outlet into another downpipe. The 95° angle provides the necessary fall to promote good flow and the standardised 40mm female connections on all three sockets makes it simple to install.

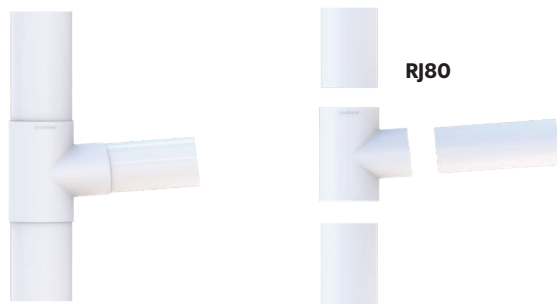

Connecting to Metal Spouting

A durable Marley RP80 downpipe system can easily be connected to flat bottom metal spouting using an MC11.80 dropper. Cut a hole in the spouting, insert the Marley dropper, sealing it with a quality outdoor waterproof sealant. Then simply attach the downpipe drop with a stainless steel screw. This will make it easy to remove the downpipe should any maintenance or repair be required in the future.

Code: MC11.80



RP80 Accessories

Marley offers a range of RP80 accessories in a range of colours to complete the system:

- Adaptors to connect downpipes to stormwater
- Curve and Twist rainwater harvesting products
- Colour-matched solvent cement to connect components
- Spreader kits to evenly distribute rainwater from upper roofs.



Component Selector

When selecting a colour add the corresponding colour extension to the product code.

E.g. RP80.**GYF** = RP80 3m length in Grey Friars

Scan here for colour options and colour code extensions



| Component | Product | Product Code |
|--|---|--------------|
| Round Downpipe 80mm 3m Length NB: Nonsocketed – use jointing socket RS80 |  | RP80_ |
| 95° F+F Bend 80mm |  | RB2.80_ |
| 95° M+F Bend 80mm |  | RB4.80_ |
| 43° F+F Bend 80mm |  | RB3.80_ |
| 43° M+F Bend 80mm |  | RB5.80_ |
| Jointing Socket 80mm |  | RS80_ |
| 95° Junction 80mm |  | RJ80_ |
| Pipe Clip-Saddle 80mm |  | RC80_ |
| Pipe Clip Adjustable 80mm Ideal for weatherboards |  | RC80.2_ |
| Pipe Clip Adjustable Spacer 80mm For stepped cladding systems |  | RC80.2S_ |
| Adaptor 80 to 90mm |  | RA80.90_ |
| Adaptor 80 to 100mm |  | RA80.100_ |
| Downpipe Spreader Kit 80mm |  | SKIT80_ |
| End Cap 80mm |  | CS80_ |
| Dropper Outlet Also for connecting RP80 to metal spouting |  | MC11.80_ |
| Curve® Leaf Diverter Protect water tanks |  | CURVE_ |
| Twist® Water Diverter For extra water supply |  | TWIST_ |
| Solvent Welding Cement - 180g Tube |  | MCS_ |

Note: Gloss levels may vary between building materials. Actual colours may vary slightly from those shown. For a more accurate colour comparison, please request a product sample.

Technical Information

Diameter: 80mm (nominal size)

Material: uPVC
(Unplasticised PVC)

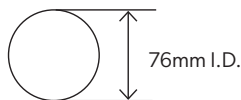

| Roof Pitch | Roof plane area served by the downpipe (m ²) |
|------------|--|
| 0°–25° | 85 |
| 25°–35° | 70 |
| 35°–45° | 60 |
| 45°–55° | 50 |

*Based on average rainfall intensity of 100mm/hr.
Refer to BRANZ Bulletin 509.

Use with Potable water:

The RP80 system is certified for use with drinking water as per the requirements of AS/NZS 4020

Environmental certification: ISO 14001, BEP certification

Compatible Marley Spouting systems: Classic®, Stormcloud®, FL2®, Typhoon®

NB. The Marley RP80 80mm round downpipe system can be used in 'wet' or 'charged' systems that are subject to head pressure however should not be used inside wall or ceiling cavities. Care should be taken to ensure that all joints are sealed properly using Marley MCS solvent. Marley does not recommend uPVC downpipes be buried, instead Stormwater/DWV pipe should be used for this application.

Installation

Marley downpipe systems are intuitively designed as a modular system, making repair and replacement much simpler. However, there is a technical element to installing Marley downpipes so if you are unsure, Marley recommends you seek advice from a trade professional. Alternatively for a step by step guide refer to our DIY Guide at www.marley.co.nz

Use a stainless steel screw and not Marley MCS to attach the downpipe drop to the spouting outlet or dropper. This will make it easy to remove the downpipe should any maintenance or repair be required in the future.

Vertical Installation:

Place the first downpipe clip a maximum of 200mm from the bend using two stainless steel screws.

Ensure the second and subsequent clips are spaced no more than 1.2 metres apart (reduce spacing to 900mm in high wind areas).



Horizontal Installation:

Place the first downpipe clip no more than 200mm from the bend or junction. Ensure the second and subsequent clips are no more than 1.0m apart. Note that horizontal downpipe should never be installed without a fall away from the spouting. Using a RB2.80 95° bend or correctly orientated RJ80 95° junction will help ensure a fall as these components have a shallow downward angle built into them.

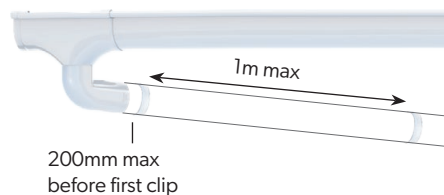

Painting

Marley has a range of pre-coloured rainwater systems available. See Stratus Design Series® at www.marley.co.nz. If painting Marley white uPVC systems, please take note of the following guidelines:

Use only light colours. The use of dark paints in exposed areas may result in excessive thermal movement of the rainwater system that can lead to leaks. Do not use solvent-based paints or cleaners as these can damage the uPVC. Paint only after installation to avoid reducing the efficacy of system joints. Do not paint the inside of the spouting or downpipes. Before painting thoroughly scrub the system components with water and detergent then dry. Apply one coat of acrylic undercoat, followed by one coat of acrylic topcoat. Apply a second coat if necessary.

Maintenance

To ensure your Marley RP80 80mm round downpipe system maintains its good looks, it should be washed at least once a year. Use warm soapy water and a soft bristled brush or cloth then simply rinse off with clean water.

Product Guarantee

Marley New Zealand Limited guarantees the purchaser of Marley spouting or downpipe products against defects in material and manufacture for a period of 15 years from the original date of purchase. For Marley's comprehensive Guarantee document please scan.



Sustainable Manufacturing

Marley is committed to creating environmentally sustainable processes and products and was the first plastics manufacturer in New Zealand to achieve ISO14001 registration. We are also Best Environmental Practice certified for our entire range of manufactured uPVC systems. This means we get our raw materials from sustainable and responsible sources, continuously work on our manufacturing processes to reduce our environmental footprint and accept our products back at the end of their useful life for recycling.

BEST ENVIRONMENTAL PRACTICE



AS/NZS 5385:2024
LICENSE No 2969



Disclaimer

This sales brochure has been compiled by Marley New Zealand Limited ("The Company") and is supplied subject to acknowledgment of the following conditions:

The sales brochure is protected by Copyright and may not be copied or reproduced in any form or by any means in whole or in part without prior consent in writing by the Company. Prices are subject to change, product specifications, usage data and advisory information may also change from time to time with advances in research and field experience. The Company reserves the right to make such changes to price or product information at any time without notice. Correct usage of the Company's products involve engineering judgements which cannot be properly made without full knowledge of all the conditions pertaining to each specific installation. The Company expressly disclaims all and any liability to any person whether supplied with this publication or not in respect of anything and of the consequences of anything done or omitted to be done by any such person in reliance whether whole or partial upon the whole or any part of the contents of this publication. No offer to trade, nor any conditions of trading, are expressed or implied by the issue or content of this manual. Nothing herein shall override the Company's Conditions of Sale, which may be obtained from the Registered Office or any Sales Office of the Company. This price book is and shall remain the property of the Company, and shall be surrendered on demand to the Company.

Our Partners



For more information: 0800 MARLEY (0800 627539) | www.marley.co.nz